

アルファ
ラジアスプレシジョン **ARPF**

Radius Precision ARPF



株式会社 MOLDINO
MOLDINO Tool Engineering, Ltd.

New Product News | No.0901-18 | 2023-6

高精度、仕上げ用 ラジラスエンドミル

Radius End Mill for High-Precision Finishing.

モジュラーミルタイプ エア穴付きを7アイテム 追加発売しました!

Introducing 7 Modular Mill Type with Air hole items!

SGタイプ SG type

平面、傾斜面、3次元形状の中仕上げから仕上げ加工に威力を発揮。
Excellent for semi-finishing and finishing of flat surfaces, sloped surfaces, or 3-dimensional shapes

SWタイプ SW type

立壁部(垂直)の高精度仕上げ加工に威力を発揮。
Excellent for high-accuracy finishing of standing walls (verticals)

SQタイプ SQ type

隅Rの除去加工に威力を発揮します。
Demonstrates its power when performing corner R removal.



HD7010	TH308 PN215						
グラファイト アルミニウム合金鋳物 Cast aluminum alloys	鑄鉄 Cast irons	炭素鋼 合金鋼 Carbon steels Alloy steels	ステンレス鋼 Stainless steels	プリハードン鋼 Pre-hardened steels	焼入れ鋼 45~55HRC Hardened steels 45-55HRC	焼入れ鋼 55~62HRC Hardened steels 55-62HRC	

加工
用途
Applications

中仕上
Semi
Finishing

仕上
Finishing

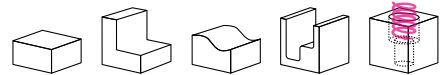

特長 01 取付け振れ精度0.02mm以下

Mounting runout accuracy of 0.02mm or less

- 高精度なボデーと取付けねじからなる独特のクランプ機構により、インサートを高精度かつ強固に取付けすることが可能です。
Unique clamp mechanism comprised of high-accuracy body and mounting screw enables inserts to be attached firmly with high accuracy.

特長 02 インサート単体のR精度±0.01mm以下

R accuracy of insert is ±0.01mm or less

- ねじれ刃形のSG、SWタイプは、R精度の基準を工具軸中心基準としましたのでより高精度になりました。
SG and SW types with helical cutting edge use the tool axis center reference as the reference for R accuracy to provide higher accuracy.

特長 03 インサート単体の刃径公差 0~-0.02mm

Blade diameter tolerance of 0 to -0.02 for inserts alone

特長 04 優れた切れ味、きれいな仕上げ面

Smooth cutting performance finish by sharp cutting edge.

- ねじれ刃形のSG、SWタイプは、食付きの良さと振動の低減により滑らかな切削が出来ます。
SG and SW types with helical cutting edge have good lead-in and reduce vibrations to enable smooth cutting.

特長 05 新材種により長寿命

New material for longer life

- マルチレイヤーコーティングにより長寿命です。
 - TH308: 焼入れ鋼、プリハードン鋼の高速、高能率加工に威力を発揮します。
 - PN215: 被削材成分の溶着が低減されるので、炭素鋼、合金鋼の仕上げ加工で良好な加工面が得られます。
- Multi-layer coating provides long life.
 - TH308: Excellent for high-speed, high-performance machining of hardened steels or pre-hardened steels.
 - PN215: Reduces welding with workpiece material components to achieve good machining surfaces when finishing carbon steels or alloy steels.

※切削性能に関する詳細は、P17~18をご参照下さい。 ※For details regarding cutting performance, see p.17 and 18.

ねじれ刃形インサートの使い分け Proper use of helical cutting edge inserts

ねじれ刃形インサートの選択方法 How to select helical cutting edge inserts

SGタイプ SG type

高効率加工 High-efficiency machining.

用途：中仕上げから仕上げ
Application: semi-finishing to finishing

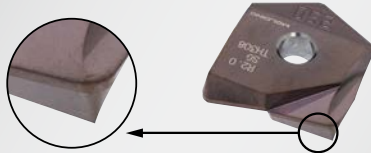

刃先部拡大
Magnified view of cutting edge

平面、傾斜面を含む
3次元形状の加工に適します。
Suitable for machining of 3-dimensional shapes
including flat surfaces and sloped surfaces.



SWタイプ SW type

立壁高精度加工 High-accuracy machining of standing walls

用途：仕上げ
Application: Finishing

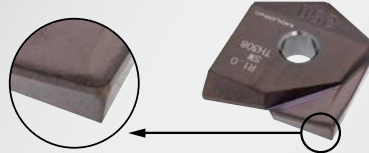

刃先部拡大
Magnified view of cutting edge

基準面となる垂直側面部(立壁部)の
高精度仕上げ加工に適します。
Suitable for high-accuracy finishing of vertical side
surfaces (standing walls) which will be used as
reference surfaces.



SQタイプ SQ type

用途：隅R除去加工
Application: Corner R removal

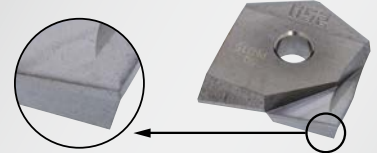

刃先部拡大
Magnified view of cutting edge

ラジラス工具で加工した後に残る
隅R部の除去加工に適します。
Suitable for removing remaining corner R areas after
machining with radius tools.



ねじれ刃形インサートがもたらす効果 An effect by helix edge shape

従来起きやすかった問題 Typical conventional problem

工具突出しが長い加工の場合、びびりが生じやすいという問題がありました。それに加えて切削抵抗が増すことによって工具は激しく振動します。そのために加工面にびびりマークがついてしまいます。

When machining with a long overhang, the increased likelihood of chattering occurring had been a problem. In addition, the tool would vibrate intensely due to increased cutting resistance. As a result, chatter marks would be made on the machined surface.

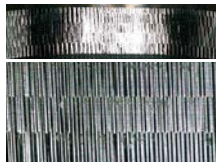

加工時の切削抵抗を緩和 Reduce cutting force

ねじれ刃形を採用したことで、切削抵抗の急激な上昇を抑えることができました。それにより、加工時のびびりを抑えることができ、仕上げ面性状が向上しました。

Helix edge shape suppresses rapid growth of cutting force. This relieves chattering while cutting and improves cutting surface finish.

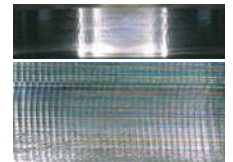

- 仕上げ面性状が改善されました。
- 突出しの長い加工でもびびりにくい。
- Improved cutting surface finish.
- Chattering is unlikely even when machining with long overhang.

加工能率と加工精度の向上が見込め、後工程の工数を減らせます。
Improved machining performance and machining accuracy can be expected, reducing work for downstream processes.

メリット

品質向上
Improved quality

コスト削減
Cost reduction

時間短縮
Time savings

工具寿命も延長 Improved tool life

切削抵抗を抑制できたことで、摩耗や衝撃からくるチッピングを減らすことができました。それにより、工具寿命も大幅に改善しました。

Less cutting force reduces chipping due to wear and impact, and tool life is improved.

PVD Technology

TH3コーティング TH308

TH3 Coating

○ 特長 Features

- TH系コーティングが進化した第3世代の新THコーティング。
- 新しい膜組成と膜構造により耐熱性と耐摩耗性が向上。
- 新マルチレイヤー構造は靱性に優れ、クラックの進行を抑制します。
 - ・ TH Coating has further evolved to the new 3rd-generation TH Coating.
 - ・ New film composition and film structure improves heat resistance and wear resistance.
 - ・ New multi-layer structure provides excellent durability and suppresses crack progression.

○ 得意分野 Strong fields

- 焼入れ鋼(45~65HRC) : SKD11, SKD61, SKH, SUS420系等の高速仕上げ加工。
- プリハードン鋼: P20, P21等の高速仕上げ加工。
- TH308は、耐摩耗性に優れた超微粒超硬合金とTH3コーティングの採用により、特に高硬度材の仕上げ加工において性能を発揮します。
 - ・ High-speed finishing of hardened steels (45 to 65 HRC) such as SKD11, SKD61, SKH, SUS420 types, etc.
 - ・ High-speed finishing of pre-hardened steels such as P20, P21, etc.
 - ・ TH308 uses ultra-fine carbide alloy with excellent wear resistance and TH3 Coating to demonstrate good performance especially for finishing of high-hardness materials.

○ 機能 Characteristics

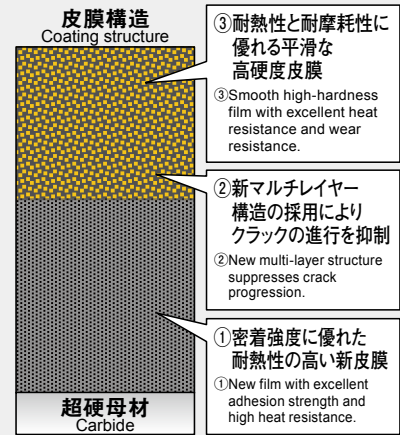

PVD Technology

PN2コーティング PN215

PN2 Coating

○ 特長 Features

- 耐酸化性に優れ、皮膜硬度が高く耐摩耗性に優れたPNコーティングを採用。
- 低摩擦の平滑な皮膜表面は潤滑性に優れ、切削加工時の被削材成分の溶着が低減されます。
 - ・ PN Coating with excellent oxidation resistance, high film hardness, and excellent wear resistance.
 - ・ Low-friction smooth film surface has excellent lubricity, reducing welding to workpiece material components during cutting machining.

○ 得意分野 Strong fields

- 炭素鋼、一般鋼: SC材、SS材等の高速仕上げ加工。
- 合金鋼: SKD11, SKD61等の高速仕上げ加工。
- プリハードン鋼: CENA1, HPM-MAGIC, NAK80等の高速仕上げ加工。
- PN215は、耐欠損性に優れた超微粒超硬合金とPN2コーティングの採用により、特に炭素鋼、合金鋼の仕上げ加工において性能を発揮します。
 - ・ Carbon steels, general steels: High-speed finishing of SC materials, SS materials, etc.
 - ・ Alloy steel: High-speed finishing of SKD11, SKD61, etc.
 - ・ Pre-hardened steels: High-speed finishing of CENA1, HPM-MAGIC, NAK80, etc.
 - ・ PN215 uses ultra-fine carbide alloy with excellent chipping resistance and PN2 Coating to demonstrate good performance especially when finishing carbon steels or alloy steels.

○ 機能 Characteristics

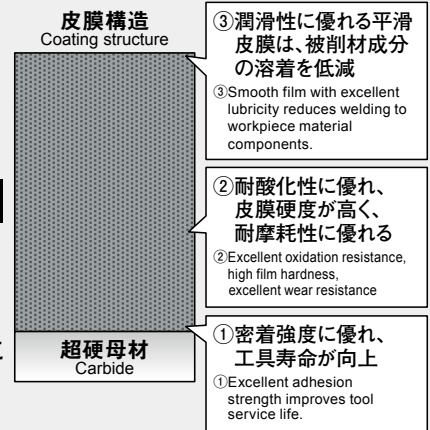

01 シャンク +1mm 刃径インサートの取り付け Mounting inserts with diameter of shank diameter +1mm

- φ13インサートはφ12ボディ、φ17インサートはφ16ボディ、φ21インサートはφ20ボディ、φ26インサートはφ25ボディに取付ける事ができます。
 - ・ A φ13 mm insert can be mounted on a φ12 mm body, a φ17 mm insert can be mounted on a φ16 mm body, a φ21 mm insert can be mounted on a φ20 mm body, or a φ26 mm insert can be mounted on a φ25 mm body.



シャンク径同一インサート装着時

When insert with same diameter as shank is mounted



シャンク+1mm径インサート装着時

When insert with diameter +1mm larger than shank diameter is mounted.

ラインナップ

Line Up

SG・SW・SQ タイプ (ねじれ刃形インサート)

SG・SW・SQ type
(helical cutting edge inserts)

P	鋼 Steels	精度 Tolerance class	THコーティング TH Coating		PNコーティング PN Coating		寸法 Size (mm)					形状 Shape	希望小売価格(円) Suggested retail price (¥)
			TH308	PN215	DC	RE	LE	INSL	T	TH308 PN215			
K	FC・FCD Cast irons		●	●	6	0.3 0.5 1	2	5	2	Fig1	11,220 11,220 11,220		
N	アルミニウム合金 Aluminum alloys		●	●	8	0.3 0.5 1 1.5 2	2.5	9.9	2.1		9,350 9,350 9,350 9,350 9,350		
H	高硬度材 Hardened steels		●	●	10	0.3 0.5 1 1.5 2 3	3	12.5	2.7		9,930 9,930 9,930 9,930 9,930 9,930		
			●	●	12	0.3 0.5 1 1.5 2 3	4	15.1	3.2		10,500 10,500 10,500 10,500 10,500 10,500		
			●	●	13	0.3 0.5 1 1.5 2 3	4	15.1	3.2		10,590 10,590 10,590 10,590 10,590 10,590		
			●	●	16	0.3 0.5 1 1.5 2 3	5	17.2	4.2	Fig2	10,850 10,850 10,850 10,850 10,850 10,850		
			●	●	17	0.3 0.5 1 1.5 2 3	5	17.2	4.2		11,000 11,000 11,000 11,000 11,000 11,000		
			●	●	20	0.3 0.5 1 1.5 2 3	7	20.9	5.2		11,460 11,460 11,460 11,460 11,460 11,460		
			●	●	21	0.3 0.5 1 1.5 2 3	7	20.9	5.2		11,790 11,790 11,790 11,790 11,790 11,790		
			●	●	25	0.3 0.5 1 1.5 2 3	8	24.4	6.2		13,250 13,250 13,250 13,250 13,250 13,250		

●：一般切削・第一推奨
General cutting, First recommendation
□：一般切削・第二推奨
General cutting, Second recommendation

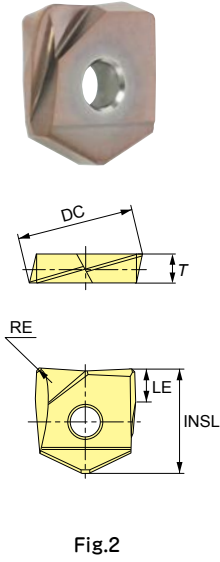
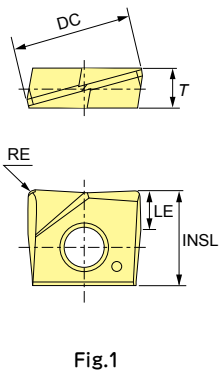

SG
タイプ
SC type

F 級
F

Fig2

※印：φ10以上のインサートは再研磨が可能です。φ16以上では最大2回まで再研磨が可能です。※ mark: Re-grinding is applicable with insert φ10 or above. Insert φ16 or above may be re-ground up to twice.

●印：標準在庫品です。●：Stocked Items.

ラインナップ

Line Up

P	鋼 Steels	精度 Tolerance class	THコーティング TH Coating		PNコーティング PN Coating		寸法 Size (mm)					形状 Shape	希望小売価格(円) Suggested retail price (¥)
	K		FC・FCD Cast irons	TH308	PN215	DC	RE	LE	INSL	T	TH308 PN215		
N	アルミニウム合金 Aluminum alloys	F級 F								Fig1			
H	高硬度材 Hardened steels												
SG タイプ SG type	※ZCFG260SG-R0.3	●	●	26	8	24.4	6.2	Fig2	Fig1	13,700			
	※ZCFG260SG-R0.5	●	●							13,700			
	※ZCFG260SG-R1.0	●	●							13,700			
	※ZCFG260SG-R1.5	●	●							13,700			
	※ZCFG260SG-R2.0	●	●							13,700			
	※ZCFG260SG-R3.0	●	●							13,700			
	※ZCFG300SG-R0.3	●	●	30	10	29.4	7.2	15,600					
	※ZCFG300SG-R0.5	●	●					15,600					
	※ZCFG300SG-R1.0	●	●					15,600					
	※ZCFG300SG-R1.5	●	●					15,600					
	※ZCFG300SG-R2.0	●	●					15,600					
	※ZCFG300SG-R3.0	●	●					15,600					
	※ZCFG320SG-R0.3	●	●	32	10	30.4	7.2	16,960					
	※ZCFG320SG-R0.5	●	●					16,960					
	※ZCFG320SG-R1.0	●	●					16,960					
	※ZCFG320SG-R1.5	●	●					16,960					
	※ZCFG320SG-R2.0	●	●					16,960					
	※ZCFG320SG-R3.0	●	●					16,960					
ZCFG06NSW-R0.3	●	●	6	2	5	2	11,220						
ZCFG06NSW-R0.5	●	●					11,220						
ZCFG080SW-R0.3	●	●	8	2.5	9.9	2.1	9,350						
ZCFG080SW-R0.5	●	●					9,350						
ZCFG080SW-R1.0	●	●	10	3	12.5	2.7	9,930						
※ZCFG100SW-R0.3	●	●					9,930						
※ZCFG100SW-R0.5	●	●					9,930						
※ZCFG100SW-R1.0	●	●					9,930						
※ZCFG120SW-R0.3	●	●					12	4	15.1	3.2	10,500		
※ZCFG120SW-R0.5	●	●									10,500		
※ZCFG120SW-R1.0	●	●	13	4	15.1	3.2	10,590						
※ZCFG130SW-R0.3	●	●					10,590						
※ZCFG130SW-R0.5	●	●	16	5	17.2	4.2	10,850						
※ZCFG130SW-R1.0	●	●					10,850						
※ZCFG160SW-R0.3	●	●	17	5	17.2	4.2	11,000						
※ZCFG160SW-R0.5	●	●					11,000						
※ZCFG160SW-R1.0	●	●	20	7	20.9	5.2	11,460						
※ZCFG170SW-R0.3	●	●					11,460						
※ZCFG170SW-R0.5	●	●	21	7	20.9	5.2	11,790						
※ZCFG170SW-R1.0	●	●					11,790						
※ZCFG200SW-R0.3	●	●	25	8	24.4	6.2	13,250						
※ZCFG200SW-R0.5	●	●					13,250						
※ZCFG200SW-R1.0	●	●	26	8	24.4	6.2	13,700						
※ZCFG210SW-R0.3	●	●					13,700						
※ZCFG210SW-R0.5	●	●	30	10	29.4	7.2	15,600						
※ZCFG210SW-R1.0	●	●					15,600						
※ZCFG250SW-R0.3	●	●	32	10	30.4	7.2	16,960						
※ZCFG250SW-R0.5	●	●					16,960						
※ZCFG250SW-R1.0	●	●					16,960						
※ZCFG260SW-R0.3	●	●					16,960						
※ZCFG260SW-R0.5	●	●					16,960						
※ZCFG260SW-R1.0	●	●					16,960						
※ZCFG300SW-R0.3	●	●					15,600						
※ZCFG300SW-R0.5	●	●					15,600						
※ZCFG300SW-R1.0	●	●					16,960						
※ZCFG320SW-R0.3	●	●					16,960						
※ZCFG320SW-R0.5	●	●					16,960						
※ZCFG320SW-R1.0	●	●					16,960						

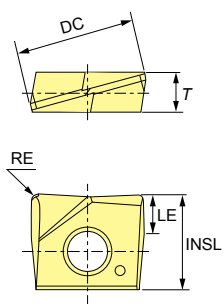

Fig.1

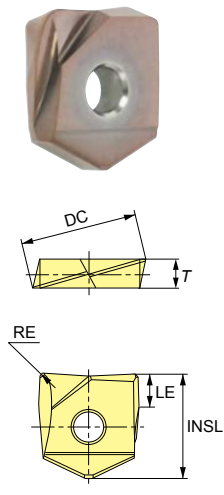

Fig.2

※印：φ10以上のインサートは再研磨が可能です。φ16以上では最大2回まで再研磨が可能です。 ※ mark: Re-grinding is applicable with insert φ10 or above. Insert φ16 or above may be re-ground up to twice.

●印：標準在庫品です。 ●：Stocked Items.

P	鋼 Steels	■	■ ：一般切削・第一推奨 General cutting, First recommendation □ ：一般切削・第二推奨 General cutting, Second recommendation
K	FC・FCD Cast irons	□	
N	アルミニウム合金 Aluminum alloys	□	
H	高硬度材 Hardened steels	□	

形状 Shape	商品コード Item code	精度 Tolerance class	PNコーティング PN Coating	寸法 Size (mm)					形状 Shape	希望小売価格(円) Suggested retail price (¥)
				PN215	DC	LE	INSL	T		PN215
 Fig.3	ZCFG080SQ	F級 F	●	8	2.5	9.9	2.1	Fig3	9,350	
	※ZCFG100SQ		●	10	3	12.5	2.7		9,930	
	※ZCFG120SQ		●	12	4	15.1	3.2		10,500	
	※ZCFG130SQ		●	13	4	15.1	3.2		10,590	
	※ZCFG160SQ		●	16	5	17.2	4.2		10,850	
	※ZCFG170SQ		●	17	5	17.2	4.2		11,000	
	※ZCFG200SQ		●	20	7	20.9	5.2		11,460	
	※ZCFG210SQ		●	21	7	20.9	5.2		11,790	
	※ZCFG250SQ		●	25	8	24.4	6.2		13,250	
	※ZCFG260SQ		●	26	8	24.4	6.2		13,700	

[注意] SG, SW, SQタイプのインサートは、アルファボールプレジジョン F「ABPF 形」ポデーに取り付け可能です。
 SG, SW, SQタイプのインサート(φ8~φ32)は、INSL寸法が従来品に対して長い設計になっております。ポデーにセットした場合の寸法にご注意下さい。
[Note] Inserts of SG, SW, SQ type can be installed on Ball Precision F "ABPF type" bodies.
 Inserts(φ8~φ32) of SG, SW, SQ type have a design with a longer INSL dimension than conventional products. Be careful of the dimension when installed on body.

※印：φ10以上のインサートは再研磨が可能です。φ16以上は最大2回まで再研磨が可能です。※ mark: Re-grinding is applicable with insert φ10 or above. Insert φ16 or above may be re-ground up to twice.
 インサートの再研磨&再コーティングも承っております。詳しくは弊社営業所までお問い合わせください。 Please inquire insert re-grinding / re-coating to sales office.

○ インサート取付け手順 Set-up procedures of Inserts

- 1** インサート座面の清掃
 エアブローなどで、インサート座面を清掃ください。
 Clean the insert seat: Using air-blow or alike, clean the seat.
- 2** インサートは、上面マークを工具本体のねじ締め付け側に合わせ、挿入する。
 Put in the insert with its top positioned to the screw-tightening side of the tool body.
- 3** 専用レンチにて高精度ねじを締め付ける。この時インサートは押さえつけないでください。
 Tighten the clamp screw with the special wrench. Please do not press down the insert during this tightening process.
- 4** 締め付け完了。
 This is the end of insert set-up.

取り付け振れ精度0.02mm以下を満足するため、上記手順に従ってください。
 In order to satisfy runout of 0.02mm or less, follow the procedure at above.

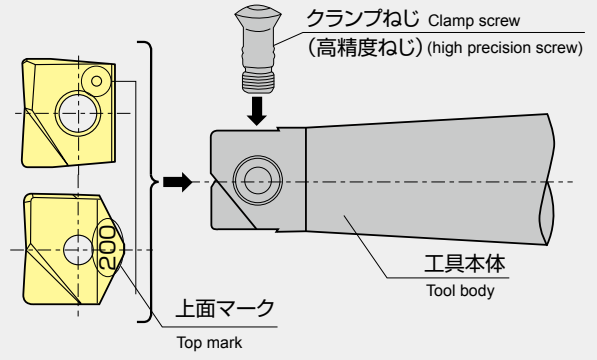

ご注意 Attention
 インサートを挿入しない状態でのクランプねじ締結は、ホルダー本体の変形に繋がる恐れがあり、インサートの取り付け不良や取付精度の劣化につながる可能性があるため決して行わないでください。
 Never tighten the clamp screw without putting the insert. The tool body may be deformed, resulting in improper insert mounting or deterioration of mounting accuracy.

インサート未挿入での空締め禁止
 Do not tighten the screw without putting insert

一般刃形インサート

General cutting edge shape inserts

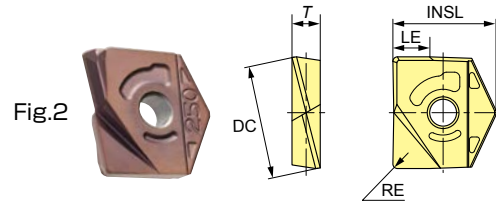
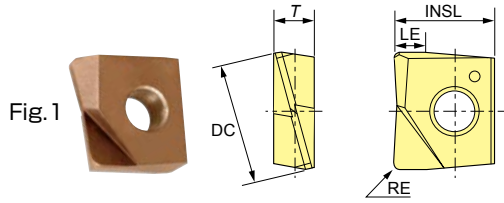

P	鋼	Steels					寸法 Size (mm)					形状 Shape	希望小売価格(円) Suggested retail price (¥)				
			PCA12M	PTH08M	HD7010	BH250	DC	RE	LE	INSL	T		PCA12M	PTH08M	HD7010 BH250		
K	FC・FCD	Cast irons	☐	☐	☐												
	グラファイト	Graphite			☐												
N	アルミニウム合金	Aluminum alloys			☐												
H	高硬度材	Hardened steels	☐	☐													

商品コード Item code	精度 Tolerance class	Cコーティング C Coating	THコーティング TH Coating	HDコーティング HD Coating	CBN	寸法 Size (mm)					形状 Shape	希望小売価格(円) Suggested retail price (¥)					
						PCA12M	PTH08M	HD7010	BH250	DC		RE	LE	INSL	T	PCA12M	PTH08M
ZCFW060-R0.3	F級 F		●	●※	—												
ZCFW060-R0.5			●	—		6	0.3					Fig.1	—	11,220	56,100		
ZCFW060-R1.0			●	—			0.5	2	5.0	2.0			—	11,220	—		
ZCFW080-R0.3			●	●	●※	—								—	11,220	—	
ZCFW080-R0.5			●	●	—		8	0.3	2.5	9.7	2.1			7,790	9,350	46,690	
ZCFW080-R1.0			●	●	—			0.5						7,790	9,350	—	
※ZCFW100-R0.3			●	●	●※	—		1.0						7,790	9,350	—	
※ZCFW100-R0.5			●	●	—			1.0						8,280	9,930	49,600	
※ZCFW100-R1.0			●	●	—			0.5						8,280	9,930	—	
※ZCFW100-R1.5			●	●	—		10	1.0	3	12.0	2.7			8,280	9,930	—	
※ZCFW100-R2.0			●	●	—			1.5						8,280	9,930	—	
※ZCFW100-R3.0			●	●	—			2.0						8,280	9,930	—	
※ZCFW120-R0.3			●	●	●※	—		3.0	4					8,280	9,930	—	
※ZCFW120-R0.5			●	●	—			0.3						8,750	10,500	52,410	
※ZCFW120-R1.0			●	●	—			0.5						8,750	10,500	—	
※ZCFW120-R1.5			●	●	—		12	1.0	4	14.6	3.2			8,750	10,500	—	
※ZCFW120-R2.0			●	●	—			1.5						8,750	10,500	—	
※ZCFW120-R3.0			●	●	—			2.0						8,750	10,500	—	
※ZCFW120-R3.0			●	●	—			3.0						8,750	10,500	—	
※ZCFW160-R0.3			●	●	●※	—		0.3						9,050	10,850	54,200	
※ZCFW160-R0.5			●	●	—			0.5						9,050	10,850	—	
※ZCFW160-R1.0			●	●	●	●	16	1.0	5	16.6	4.2			9,050	10,850	93,810	
※ZCFW160-R1.5			●	●	—			1.5						9,050	10,850	—	
※ZCFW160-R2.0			●	●	—	●		2.0						9,050	10,850	93,810	
※ZCFW160-R3.0			●	●	—	●		3.0						9,050	10,850	—	
※ZCFW200-R0.3			●	●	●※	—		0.3						9,050	10,850	—	
※ZCFW200-R0.5			●	●	—			0.5						9,510	11,460	57,010	
※ZCFW200-R1.0			●	●	●	●	20	1.0	6	19.9	5.2			9,510	11,460	99,190	
※ZCFW200-R1.5			●	●	—			1.5						9,510	11,460	—	
※ZCFW200-R2.0			●	●	—	●		2.0						9,510	11,460	99,190	
※ZCFW200-R3.0			●	●	—			3.0						9,510	11,460	—	
※ZCFW250-R0.3			●	●	—			0.3						11,030	13,250	—	
※ZCFW250-R0.5			●	●	—			0.5						11,030	13,250	—	
※ZCFW250-R1.0			●	●	●	●	25	1.0	8	22.6	6.2			11,030	13,250	101,670	
※ZCFW250-R2.0		●	●	—	●		2.0						11,030	13,250	101,670		
※ZCFW250-R3.0		●	●	—			3.0						11,030	13,250	—		
※ZCFW300-R0.3		●	●	—			0.3						13,030	15,600	—		
※ZCFW300-R0.5		●	●	—			0.5						13,030	15,600	—		
※ZCFW300-R1.0		●	●	●	●	30	1.0	10	27.2	7.2			13,030	15,600	115,570		
※ZCFW300-R2.0		●	●	—	●		2.0						13,030	15,600	115,570		
※ZCFW300-R3.0		●	●	—			3.0						13,030	15,600	—		
※ZCFW320-R0.3		●	●	—			0.3						14,030	16,960	—		
※ZCFW320-R0.5		●	●	—			0.5						14,030	16,960	—		
※ZCFW320-R1.0		●	●	—		32	1.0	10	28.2	7.2			14,030	16,960	—		
※ZCFW320-R2.0		●	●	—			2.0						14,030	16,960	—		
※ZCFW320-R3.0		●	●	—			3.0						14,030	16,960	—		

■：一般切削・第一推奨
General cutting, First recommendation
☐：一般切削・第二推奨
General cutting, Second recommendation

※印：HD7010は再研磨不可です。 ※印：HD7010以外のφ10以上のインサートは再研磨が可能です。φ16以上では最大2回まで再研磨が可能です。
※mark: HD7010 insert cannot be reground. ※mark: Inserts with diameters of φ10 or more except HD7010 can be reground. Insert φ16 or above may be re-ground up to twice.

インサートの再研磨&再コーティングも承っております。詳しくは弊社営業所までお問い合わせください。
Please inquire insert re-grinding / re-coating to sales office.

○は数字、□は英文字が入ります。
 Numeric figure in a circle ○ and alphabetical character comes in a square □.

鋼シャンク・超硬シャンク

Steel shank · Carbide shank

ARPF○○S○○ (□○○○/□○○○)

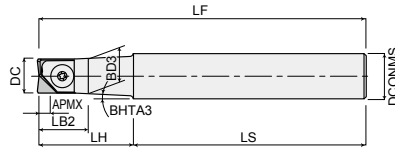

Aタイプ(首下テーパ)
Type A (Taper Neck)

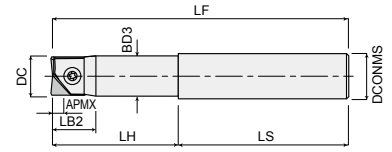

Bタイプ(首下ストレート)
Type B (Straight Neck)

	商品コード Item code	在庫 Stock	No. of inserts 数	寸法 Size (mm)									形状 Shape	適用インサート Inserts	希望小売 価格(円) Suggested retail price (¥)
				DC	LF	DCONMS	APMX	LB2	LH	BHTA3	BD3	LS			
Regular shank	ARPF06S10	●	1	6	80	10	2.0	15	30	8.25°	5.4	50	A	ZCFG06NS□-R○○ ZCFW060-R○○	15,730
	ARPF08S12	●	1	8	100(100.2)	12	2.5	10(10.2)	22(22.2)	9.5°	7.5	78	A	ZCFG080S□(R○○) ZCFW080-R○○	18,430
	ARPF10S12	●	1	10	100(100.4)	12	3.0	13(13.4)	25(25.4)	3°	9.5	75	A	ZCFG100S□(R○○) ZCFW100-R○○	19,240
	ARPF12S12	●	1	12 13*	110(110.6)	12	4.0	21(21.6)	30(30.6)	—	11.5	80	B	ZCFG120S□(R○○) ZCFW120-R○○ ZCFG130S□(R○○)*	20,070
	ARPF16S16	●	1	16 17*	130(130.6)	16	5.0	27(27.6)	50(50.6)	—	15	80	B	ZCFG160S□(R○○) ZCFW160-R○○ ZCFG170S□(R○○)*	23,350
	ARPF20S20	●	1	20 21*	140(141)	20	6.0	35(36)	60(61)	—	19	80	B	ZCFG200S□(R○○) ZCFW200-R○○ ZCFG210S□(R○○)*	26,870
	ARPF25S25	●	1	25 26*	150(151.8)	25	8.0	43(44.8)	70(71.8)	—	24	80	B	ZCFG250S□(R○○) ZCFW250-R○○ ZCFG260S□(R○○)*	34,260
	ARPF30S32	●	1	30	160(162.2)	32	10.0	55(57.2)	80(82.2)	—	29	80	B	ZCFG300S□-R○○ ZCFW300-R○○	41,060
	ARPF32S32	●	1	32	160(162.2)	32	10.0	58(60.2)	80(82.2)	—	31	80	B	ZCFG320S□-R○○ ZCFW320-R○○	41,060
Under neck long	ARPF08S12L	●	1	8	130(130.2)	12	2.5	10(10.2)	50(50.2)	3°	7.5	80	A	ZCFG080S□(R○○) ZCFW080-R○○	22,180
	ARPF10S16L	●	1	10	150(150.4)	16	3.0	13(13.4)	50(50.4)	4.5°	9.5	100	A	ZCFG100S□(R○○) ZCFW100-R○○	23,120
	ARPF12S16L	●	1	12 13*	160(160.6)	16	4.0	21(21.6)	60(60.6)	2°	11.5	100	A	ZCFG120S□(R○○) ZCFW120-R○○ ZCFG130S□(R○○)*	23,940
	ARPF16S16L	●	1	16 17*	165(165.6)	16	5.0	27(27.6)	65(65.6)	—	15	100	B	ZCFG160S□(R○○) ZCFW160-R○○ ZCFG170S□(R○○)*	28,040
	ARPF20S20L	●	1	20	180(181)	20	6.0	35(36)	80(81)	—	19	100	B	ZCFG200S□(R○○) ZCFW200-R○○	32,260
	ARPF20S20L120	●	1	20 21*	220(221)	20	6.0	35(36)	120(121)	—	19	100	B	ZCFG200S□(R○○) ZCFW200-R○○	32,260
	ARPF20S20L150	●	1	20	250(251)	20	6.0	35(36)	150(151)	—	19	100	B	ZCFG210S□(R○○)*	32,260
	ARPF25S25L	●	1	25	200(201.8)	25	8.0	43(44.8)	90(91.8)	—	24	110	B	ZCFG250S□(R○○) ZCFW250-R○○	41,060
	ARPF25S32L150	●	1	26*	250(251.8)	32	8.0	43(44.8)	150(151.8)	—	24	100	B	ZCFG260S□(R○○)*	49,270
	ARPF30S32L	●	1	30	220(222.2)	32	10.0	55(57.2)	100(102.2)	—	29	120	B	ZCFG300S□-R○○ ZCFW300-R○○	49,270
	ARPF30S32L150	●	1	30	250(252.2)	32	10.0	55(57.2)	150(152.2)	—	29	100	B	ZCFG300S□-R○○ ZCFW300-R○○	49,270
ARPF30S32L200	●	1	30	300(302.2)	32	10.0	55(57.2)	200(202.2)	—	29	100	B	ZCFG300S□-R○○ ZCFW300-R○○	49,270	
ARPF32S32L	●	1	32	220(222.2)	32	10.0	58(60.2)	100(102.2)	—	31	120	B	ZCFG320S□-R○○ ZCFW320-R○○	49,270	
Long shank	ARPF16S16E	●	1	16 17*	200(200.6)	16	5.0	27(27.6)	65(65.6)	—	15	135	B	ZCFG160S□(R○○) ZCFW160-R○○ ZCFG170S□(R○○)*	28,040
	ARPF20S20E	●	1	20 21*	250(251)	20	6.0	35(36)	80(81)	—	19	170	B	ZCFG200S□(R○○) ZCFW200-R○○ ZCFG210S□(R○○)*	32,260
	ARPF25S25E	●	1	25	300(301.8)	25	8.0	43(44.8)	90(91.8)	—	24	210	B	ZCFG250S□(R○○) ZCFW250-R○○	41,060
	ARPF25S32E	●	1	25	300(301.8)	32	8.0	43(44.8)	100(101.8)	3.5°	24	200	A	ZCFG260S□(R○○)*	42,700
	ARPF30S32E	●	1	30	350(352.2)	32	10.0	55(57.2)	100(102.2)	—	29	250	B	ZCFG300S□-R○○ ZCFW300-R○○	49,270
	ARPF30S42E	●	1	30	350(352.2)	42	10.0	55(57.2)	120(122.2)	5.3°	29	230	A	ZCFG300S□-R○○ ZCFW300-R○○	58,190
	ARPF32S32E	●	1	32	350(352.2)	32	10.0	58(60.2)	100(102.2)	—	31	250	B	ZCFG320S□-R○○ ZCFW320-R○○	49,270
Carbide shank	ARPF06S06W	●	1	6	90	6	2.0	10.3	25	—	5.5	65	B	ZCFG06NS□-R○○ ZCFW060-R○○	34,960
	ARPF06S06WL65	●	1	6	120	6	2.0	10.3	65	—	5.5	55	B	ZCFG06NS□-R○○ ZCFW060-R○○	35,910
	ARPF08S08WL	●	1	8	130(130.2)	8	2.5	65(65.2)	65(65.2)	—	7.5	65	B	ZCFG080S□(R○○) ZCFW080-R○○	45,290
	ARPF10S10WL	●	1	10	140(140.4)	10	3.0	18(18.4)	75(75.4)	—	9.5	65	B	ZCFG100S□(R○○) ZCFW100-R○○	49,510
	ARPF12S12WL	●	1	12 13*	150(150.6)	12	4.0	21(21.6)	85(85.6)	—	11.5	65	B	ZCFG120S□(R○○) ZCFW120-R○○ ZCFG130S□(R○○)*	59,600
	ARPF16S16WE	●	1	16 17*	200(200.6)	16	5.0	27(27.6)	120(120.6)	—	15	80	B	ZCFG160S□(R○○) ZCFW160-R○○ ZCFG170S□(R○○)*	82,240
	ARPF20S20WE	●	1	20 21*	250(251)	20	6.0	35(36)	150(151)	—	19	100	B	ZCFG200S□(R○○) ZCFW200-R○○ ZCFG210S□(R○○)*	113,080
	ARPF25S25WE	●	1	25 26*	300(301.8)	25	8.0	43(44.8)	190(191.8)	—	24	110	B	ZCFG250S□(R○○) ZCFW250-R○○ ZCFG260S□(R○○)*	170,090
	ARPF30S32WE	●	1	30	350(352.2)	32	10.0	55(57.2)	230(232.2)	—	29	120	B	ZCFG300S□-R○○ ZCFW300-R○○	267,450
	ARPF32S32WE	●	1	32	350(352.2)	32	10.0	58(60.2)	230(232.2)	—	31	120	B	ZCFG320S□-R○○ ZCFW320-R○○	267,450

※φ13インサートはφ12ボディ、φ17インサートはφ16ボディ、φ21インサートはφ20ボディ、φ26インサートはφ25ボディに取付ける事ができます。
 ※A φ13 mm insert can be mounted on a φ12 mm body, a φ17 mm insert can be mounted on a φ16 mm body, a φ21 mm insert can be mounted on a φ20 mm body, or a φ26 mm insert can be mounted on a φ25 mm body.
 【注意】() 寸法は、ZCFGタイプのインサート取り付け時を示します。【Note】Dimensions in parentheses () are with ZCFG type inserts installed.

ラインナップ

Line Up

モジュラーミルタイプ

Modular Mill Type

ARPFM

○は数字、□は英文字が入ります。
Numerical figure in a circle ○ and alphabetical character comes in a square □.

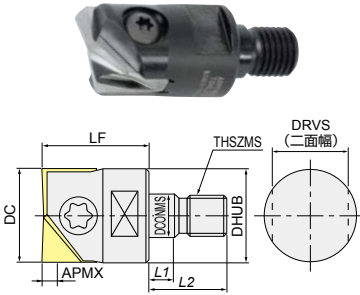

商品コード Item code	在庫 Stock No. of inserts 在庫数	寸法 Size (mm)										適用インサート Inserts	希望小売 価格(円) Suggested retail price(¥)
		DC	LF	APMX	DCONMS	THSZMS	DHUB	L1	L2	DRVS			
ARPFM10	●	1	10	26(26.4)	3	6.5	M6	9.8	5.5	14.5	7	ZCFG100S□(R○○) ZCFW100-R○○	19,240
ARPFM12	●	1	12 13*	26(26.6)	4	6.5	M6	9.8	5.5	14.5	7	ZCFG120S□(R○○) ZCFW120-R○○ ZCFG130S□(R○○)*	20,070
ARPFM16	●	1	16 17*	32(32.6)	5	8.5	M8	12.8	5.5	17	10	ZCFG160S□(R○○) ZCFW160-R○○ ZCFG170S□(R○○)*	23,350
ARPFM20	●	1	20 21*	38(39)	6	10.5	M10	17.8	5.5	19	15	ZCFG200S□(R○○) ZCFW200-R○○ ZCFG210S□(R○○)*	26,870
ARPFM25	●	1	25 26*	38(39.8)	8	12.5	M12	20.8	5.5	22	17	ZCFG250S□(R○○) ZCFW250-R○○ ZCFG260S□(R○○)*	34,260
ARPFM30	●	1	30	43(45.2)	10	17	M16	28.8	6	23	22	ZCFG300S□(R○○) ZCFW300-R○○	41,060
ARPFM32	●	1	32	43(45.2)	10	17	M16	28.8	6	23	22	ZCFG320S□(R○○) ZCFW320-R○○	41,060

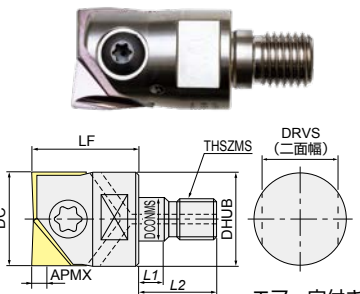

商品コード Item code	在庫 Stock No. of inserts 在庫数	寸法 Size (mm)										適用インサート Inserts	希望小売 価格(円) Suggested retail price(¥)
		DC	LF	APMX	DCONMS	THSZMS	DHUB	L1	L2	DRVS			
ARPFM10-H	●	1	10	26 (26.4)	3	6.5	M6	9.8	5.5	14.5	7	ZCFG100S□(R○○) ZCFW100-R○○	21,120
ARPFM12-H	●	1	12 13*	26 (26.6)	4	6.5	M6	9.8	5.5	14.5	7	ZCFG120S□(R○○) ZCFW120-R○○ ZCFG130S□(R○○)*	22,060
ARPFM16-H	●	1	16 17*	32 (32.6)	5	8.5	M8	12.8	5.5	17	10	ZCFG160S□(R○○) ZCFW160-R○○ ZCFG170S□(R○○)*	25,700
ARPFM20-H	●	1	20 21*	38 (39)	6	10.5	M10	17.8	5.5	19	15	ZCFG200S□(R○○) ZCFW200-R○○ ZCFG210S□(R○○)*	29,570
ARPFM25-H	●	1	25 26*	38 (39.8)	8	12.5	M12	20.8	5.5	22	17	ZCFG250S□(R○○) ZCFW250-R○○ ZCFG260S□(R○○)*	37,670
ARPFM30-H	●	1	30	43 (45.2)	10	17	M16	28.8	6	23	22	ZCFG300S□(R○○) ZCFW300-R○○	45,170
ARPFM32-H	●	1	32	43 (45.2)	10	17	M16	28.8	6	23	22	ZCFG320S□(R○○) ZCFW320-R○○	45,170

※φ13インサートはφ12ボディ、φ17インサートはφ16ボディ、φ21インサートはφ20ボディ、φ26インサートはφ25ボディに取付ける事ができます。

※A φ13 mm insert can be mounted on a φ12 mm body, a φ17 mm insert can be mounted on a φ16 mm body, a φ21 mm insert can be mounted on a φ20 mm body, or a φ26 mm insert can be mounted on a φ25 mm body.

[注意] モジュラーミル及び専用シャンク、専用アークの「工具端面」「モジュラーねじ部」にグリスなどの潤滑剤は塗布しないでください。
() 寸法は、ZCFGタイプのインサート取り付け時を示します。

[Note] Do not apply lubricants such as grease, etc. to the "contact faces" and "modular screws" of the "modular mill", "dedicated shanks" and "dedicated arbor".
Dimensions in parentheses () are with ZCFG type inserts installed.

部品番号

Parts

部品名 Parts	形状 Shape	クランプねじ Clamp screw		ドライバー/レンチ Screw Driver/Wrench			ねじ焼き付き防止剤 Screw anti-seizure agent		
		締付トルク Fastening torque (N·m)	希望小売価格(円) Suggested retail price (¥)	A	B	C	希望小売価格(円) Suggested retail price (¥)	タイプ Type	
適用カッター Cutter body									
ARPF06S ○(W/WL ○)		581-140	0.5	1,970	104-T6	1,800	A	P-37	1,010
ARPF08S ○(L/WL)		581-141	1.1	1,490	104-T8	1,800	A		
ARPF10S ○(L/WL) ARPFM10(-H)		581-142	2.2	1,490	104-T10	1,920	A		
ARPF12S ○(L/WL) ARPFM12(-H)		581-143	4.9	1,490	105-T20	2,120	B		
ARPF16S ○(L/E/WE) ARPFM16(-H)		581-144	4.9	1,490	101-T25S	1,440	B		
ARPF20S ○(L○○/E/WE) ARPFM20(-H)		581-145	6.9	1,490	105-T30A	2,120	C		
ARPF25S ○(L○○/E/WE) ARPFM25(-H)		581-146	9.8	1,710					
ARPF30S ○(L○○/E/WE) ARPFM30(-H)		581-147	9.8	1,710					
ARPF32S ○(L/E/WE) ARPFM32(-H)									

[注意] クランプねじは消耗品です。使用環境により交換寿命は変化しますので早めの交換をお願い致します。

[Note] The clamp screw is a consumable part. Since replacement life depends on the use environment, it is recommended that it be replaced at an early stage.

モジュラーミル専用シャンク

The Shanks for Modular Mill

超硬シャンク Carbide Shank

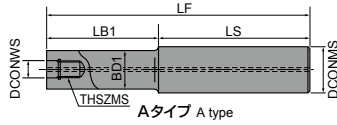

Aタイプ A type

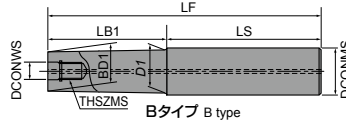

Bタイプ B type

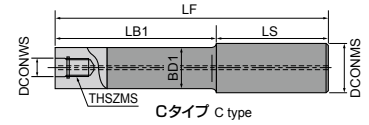

Cタイプ C type

商品コード Item code	在庫 Stock	寸法 Size (mm)								タイプ Type	適用 カッタ Cutter body	エアーク 有無 With/ without air hole	希望小売 価格(円) Suggested retail price (¥)
		DCONWS	THSZMS	LF	LB1	LS	BD1	DCONMS	D1				
ASC10-6.5-74-24Z	●	6.5	M6	74	24	50	9.3	10	-	A	φ10	○	25,810
ASC10-6.5-84-34Z	●			84	34	50							27,930
ASC10-6.5-114-49Z	●			114	49	65							30,270
ASC10-6.5-114-24Z	●			24	24	90							30,270
ASC12-6.5-74-24Z	●	6.5	M6	74	24	50	11	12	11.5	B	φ10 φ12	○	36,020
ASC12-6.5-94-44Z	●			94	44	50							37,430
ASC12-6.5-129-64Z	●			129	64	65							39,540
ASC12-6.5-129-24Z	●			24	24	105							39,540
ASC16-8.5-95-30Z	●	8.5	M8	95	30	65	14.5	16	15.5	B	φ16	○	48,100
ASC16-8.5-120-55Z	●			120	55	65							52,560
ASC16-8.5-140-75Z	●			140	75	65							55,960
ASC16-8.5-160-95Z	●			160	95	65							58,900
ASC16-8.5-160-30Z	●	160	30	130	58,900								
ASC20-10.5-120-50Z	●	10.5	M10	120	50	70	18.5	20	19.5	B	φ20	○	56,780
ASC20-10.5-170-90Z	●			170	90	80							63,590
ASC20-10.5-220-120Z	●			220	120	100							69,920
ASC20-10.5-270-150Z	●			270	150	120							88,690
ASC20-10.5-220-50Z	●	10.5	M10	220	50	170	18.5	20	19.5	B	φ20	○	69,920
ASC20-10.5-270-50Z	●			270		220							88,690
ASC25-12.5-145-65	●	12.5	M12	145	65	80	23	25	-	C	φ25	○	64,990
ASC25-12.5-215-115	●			215	115	100							76,130
ASC25-12.5-265-145	●			265	145	120							88,690
ASC25-12.5-315-195	●			315	195	120							114,370
ASC25-12.5-265-65	●	12.5	M12	265	65	200	23	25	-	C	φ25	○	88,690
ASC25-12.5-315-65	●			315		250							114,370
ASC32-17-160-80	●	17	M16	160	80	80	28	32	-	C	φ32	○	98,540
ASC32-17-210-110	●			210	110	100							99,710
ASC32-17-260-140	●			260	140	120							118,480
ASC32-17-310-190	●			310	190	120							160,710
ASC32-17-360-240	●	360	240	120	202,930								
ASC32-17-260-80	●	17	M16	260	80	180	28	32	-	C	φ32	○	118,480
ASC32-17-310-80	●			310		230							160,710
ASC32-17-360-80	●			360		280							202,930

[注意] 市販のミーリングチャック、焼ばめホルダにて使用できます。

[Note] Can be used with commercially available milling chucks or shrink-fit holders.

鋼シャンク Steel Shank

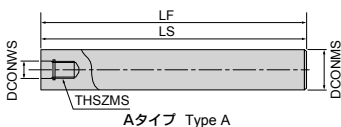

Aタイプ Type A

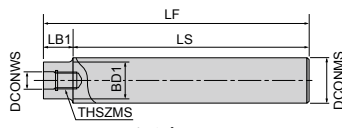

Bタイプ Type B

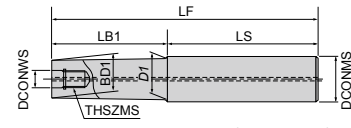

Cタイプ(首テーパ) Type C (Tapered neck)

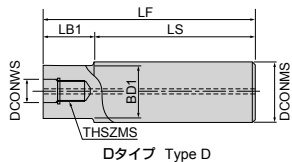

Dタイプ Type D

商品コード Item code	在庫 Stock	寸法 Size (mm)								タイプ Type	適用 カッタ Cutter body	希望小売 価格(円) Suggested retail price (¥)
		DCONWS	THSZMS	LF	LB1	LS	BD1	DCONMS	D1			
AS10-6.5-74-0	●	6.5	M6	74	-	74	-	10	-	A	φ10	20,890
AS12-6.5-84-4	●	6.5	M6	84	4	80	11	12	-	B	φ12	24,290
AS16-8.5-95-15	●	8.5	M8	95	15	80	14.5	16	15.5	C	φ16	28,160
AS20-10.5-100-20	●	10.5	M10	100	20	80	18	20	-	D	φ20	31,680
AS25-12.5-115-35	●	12.5	M12	115	35	80	23	25	-	D	φ25	35,440
AS32-17-110-30	●	17	M16	110	30	80	28	32	-	D	φ30 φ32	42,470

[注意] 市販のミーリングチャックにて使用できます。

[Note] Commercial milling chucks can be used.

鋼シャンク Steel Shank

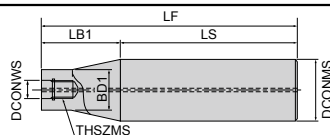

商品コード Item code	在庫 Stock	寸法 Size (mm)								適用 カッタ Cutter body	希望小売 価格(円) Suggested retail price (¥)
		DCONWS	THSZMS	LF	LB1	LS	BD1	DCONMS	D1		
AS42-17-360-90	●	17	M16	360	90	270	28	42	-	φ30 φ32	80,940

[注意] 市販のミーリングチャックにて使用できます。

[Note] Commercial milling chucks can be used.

ラインナップ

Line Up

モジュラーミル用アーバ

Modular Mill Arbor

BT30

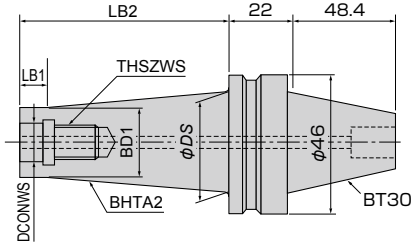

※首部分は、ユーザー様にて追加加工可能です。
※For neck section, additional machining to user specifications is possible.

商品コード Item code	在庫 Stock	寸法 Size (mm)						
		DCONWS	THSZWS	BD1	φDS	LB2	LB1	BHTA2
BT30-6.5-30-9.7						30	5	17°
BT30-6.5-55-9.7		6.5	M6	9.7	25	55	10	9.6°
BT30-6.5-85-9.7						80	10	6.2°
BT30-8.5-25-15						25	5	20.6°
BT30-8.5-50-15		8.5	M8	15	30	50	10	10.6°
BT30-8.5-75-15						75	10	6.6°
BT30-10.5-20-18						20	5	29.5°
BT30-10.5-45-18		10.5	M10	18	35	45	10	13.7°
BT30-10.5-70-18						70	10	8.1°
BT30-12.5-15-21						15	5	32.3°
BT30-12.5-40-21		12.5	M12	21	40	40	10	17.6°
BT30-12.5-65-21						65	10	9.8°
BT30-12.5-85-21						85	10	7.2°
BT30-17-10-28						10	5	31°
BT30-17-35-28		17	M16	28	40	35	10	13.5°
BT30-17-60-28						60	10	6.8°

【注意】加工状況により振動が懸念される場合は、1.切り込み深さ(a_p)を低減する 2.一刃当りの送り(f_z)を低減する方法で調整下さい。
【Note】If vibrations are a concern due to the processing conditions, adjust conditions by 1.reducing cutting depth (a_p) or 2.reducing per-flute feed rate (f_z).

BT40

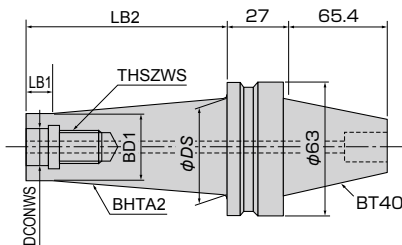

※首部分は、ユーザー様にて追加加工可能です。
※For neck section, additional machining to user specifications is possible.

商品コード Item code	在庫 Stock	寸法 Size (mm)						
		DCONWS	THSZWS	BD1	φDS	LB2	LB1	BHTA2
BT40-6.5-30-9.7						30	5	17°
BT40-6.5-55-9.7		6.5	M6	9.7	25	55	10	9.6°
BT40-6.5-80-9.7						80	10	6.2°
BT40-6.5-130-9.7						130	10	3.6°
BT40-8.5-25-15						25	5	20.6°
BT40-8.5-50-15		8.5	M8	15	30	50	10	10.6°
BT40-8.5-75-15						75	10	6.6°
BT40-8.5-125-15						125	10	3.7°
BT40-10.5-20-18						20	5	29.5°
BT40-10.5-45-18		10.5	M10	18	35	45	10	13.7°
BT40-10.5-70-18						70	10	8.1°
BT40-10.5-120-18						120	10	4.4°
BT40-12.5-15-21						15	5	32.3°
BT40-12.5-40-21		12.5	M12	21	40	40	10	17.6°
BT40-12.5-65-21						65	10	9.8°
BT40-12.5-115-21						115	10	5.2°
BT40-17-10-28						10	5	45°
BT40-17-35-28		17	M16	28	48	35	10	21.8°
BT40-17-60-28						60	10	11.3°
BT40-17-110-28						110	10	5.7°

HSK

(モジュラーミルタイプ Modular Mill Type)

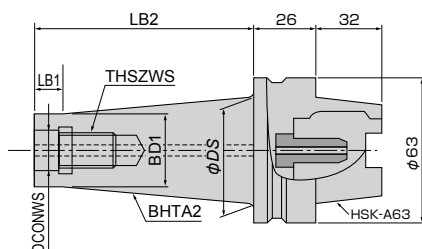

商品コード Item code	在庫 Stock	寸法 Size (mm)						希望小売 価格(円) Suggested retail price (¥)	
		DCONWS	THSZWS	BD1	φDS	LB2	LB1		BHTA2
HSK-A63-10.5-30-18	●				20.8	30	—	3°	94,560
HSK-A63-10.5-70-18	●	10.5	M10	18	25	70	10	3°	97,130
HSK-A63-10.5-70-18S					48	70	10	12°	—
HSK-A63-10.5-120-18	●				30.2	120	10	3°	101,350
HSK-A63-12.5-35-21	●				24.3	35	—	3°	95,490
HSK-A63-12.5-65-21	●	12.5	M12	21	27.5	65	10	3°	96,660
HSK-A63-12.5-65-21S					48	65	10	12°	—
HSK-A63-12.5-115-21	●				32.7	115	10	3°	101,710
HSK-A63-17-40-28	●				31.8	40	—	3°	95,490
HSK-A63-17-60-28	●	17	M16	28	33.9	60	10	3°	96,660
HSK-A63-17-60-28S					48	60	10	9.5°	—
HSK-A63-17-110-28	●				39.2	110	10	3°	101,120

標準切削条件表

Recommended Cutting Conditions

※赤字は第一推奨材種です Red indicates primary recommended insert grade.

被削材 Work material	インサート材種 Insert grade		切削条件 Cutting conditions	φ6			φ8			φ10			φ12		
	SG・SW (ねじれ刃形) (helical cutting edge inserts)	一般刃形 General edge shape		中仕上げ Semi finishing		仕上げ Finishing	中仕上げ Semi finishing		仕上げ Finishing	中仕上げ Semi finishing		仕上げ Finishing	中仕上げ Semi finishing		仕上げ Finishing
				汎用 General purpose	高速加工 High-speed processing	汎用 General purpose	高速加工 High-speed processing	汎用 General purpose	高速加工 High-speed processing	汎用 General purpose	高速加工 High-speed processing	汎用 General purpose	高速加工 High-speed processing	汎用 General purpose	高速加工 High-speed processing
炭素鋼 合金鋼 Carbon steels Alloy steels (30HRC以下) (30HRC or less)	※ PN215 TH308	PTH08M (PCA12M)	n (min ⁻¹)	8,490	16,450	16,450	6,370	11,940	11,940	5,090	9,550	9,550	4,240	7,960	7,960
			V_c (m/min)	160	310	310	160	300	300	160	300	300	160	300	300
			V_f (mm/min)	1,700	2,300	2,300	2,550	3,580	3,580	2,040	2,870	2,870	1,700	2,390	2,390
			f_z (mm/t)	0.1	0.07	0.07	0.2	0.15	0.15	0.2	0.15	0.15	0.2	0.15	0.15
			a_p (mm)	0.1	0.1	0.05	0.2	0.2	0.1	0.25	0.25	0.1	0.3	0.3	0.1
			a_e (mm)	0.6	0.3	0.2	0.8	0.4	0.2	1	0.5	0.2	1.2	0.6	0.2
炭素鋼 合金鋼 Carbon steels Alloy steels (30~45HRC)	TH308 PN215	PTH08M (PCA12M)	n (min ⁻¹)	6,370	14,850	14,850	4,770	11,150	11,150	3,820	8,920	8,920	3,180	7,430	7,430
			V_c (m/min)	120	280	280	120	280	280	120	280	280	120	280	280
			V_f (mm/min)	1,270	2,080	2,080	1,910	3,350	3,350	1,530	2,680	2,680	1,270	2,230	2,230
			f_z (mm/t)	0.1	0.07	0.07	0.2	0.15	0.15	0.2	0.15	0.15	0.2	0.15	0.15
			a_p (mm)	0.1	0.1	0.05	0.2	0.2	0.1	0.25	0.25	0.1	0.3	0.3	0.1
			a_e (mm)	0.6	0.3	0.2	0.8	0.4	0.2	1	0.5	0.2	1.2	0.6	0.2
鋳鉄 Cast irons	TH308 PN215	PTH08M (PCA12M)	n (min ⁻¹)	8,490	20,160	20,160	6,370	15,120	15,120	5,090	12,100	12,100	4,240	10,080	10,080
			V_c (m/min)	160	380	380	160	380	380	160	380	380	160	380	380
			V_f (mm/min)	2,550	4,030	4,030	3,820	6,050	6,050	3,050	4,840	4,840	2,550	4,030	4,030
			f_z (mm/t)	0.15	0.1	0.1	0.3	0.2	0.2	0.3	0.2	0.2	0.3	0.2	0.2
			a_p (mm)	0.1	0.1	0.05	0.2	0.2	0.1	0.25	0.2	0.1	0.3	0.3	0.1
			a_e (mm)	0.6	0.3	0.2	0.8	0.4	0.2	1	0.4	0.2	1.2	0.6	0.2
グラファイト Graphite		HD7010	n (min ⁻¹)	15,920	21,220	21,220	11,940	15,920	15,920	9,550	12,740	12,740	7,960	10,620	10,620
			V_c (m/min)	300	400	400	300	400	400	300	400	400	300	400	400
			V_f (mm/min)	3,180	6,370	4,240	4,780	9,550	6,370	3,820	7,640	5,100	3,190	6,370	4,240
			f_z (mm/t)	0.1	0.15	0.1	0.2	0.3	0.2	0.2	0.3	0.2	0.2	0.3	0.2
			a_p (mm)	0.3	0.15	0.15	0.4	0.2	0.2	0.5	0.3	0.2	0.6	0.4	0.2
			a_e (mm)	0.6	0.6	0.2	0.8	0.8	0.25	1	0.8	0.25	1.2	0.9	0.3
アルミニウム 合金鋳物 Cast aluminum alloys AC4A, ADC12等 etc	PN215	HD7010	n (min ⁻¹)	15,920	26,530	26,530	11,940	19,900	19,900	9,550	15,920	15,920	7,960	13,270	13,270
			V_c (m/min)	300	500	500	300	500	500	300	500	500	300	500	500
			V_f (mm/min)	3,180	10,610	5,310	4,780	15,920	7,960	3,820	12,740	6,370	3,190	10,620	5,310
			f_z (mm/t)	0.1	0.2	0.1	0.2	0.4	0.2	0.2	0.4	0.2	0.2	0.4	0.2
			a_p (mm)	0.3	0.15	0.15	0.4	0.2	0.2	0.5	0.3	0.2	0.6	0.4	0.2
			a_e (mm)	0.6	0.6	0.2	0.8	0.8	0.25	1	0.8	0.25	1.2	0.9	0.3
焼入れ鋼 Hardened steels 45~55HRC	TH308 PN215	PTH08M (PCA12M)	n (min ⁻¹)	5,310	14,850	14,850	3,980	11,150	11,150	3,180	8,920	8,920	2,650	7,430	7,430
			V_c (m/min)	100	280	280	100	280	280	100	280	280	100	280	280
			V_f (mm/min)	850	1,190	1,190	800	1,120	1,120	640	890	890	530	740	740
			f_z (mm/t)	0.08	0.04	0.04	0.1	0.05	0.05	0.1	0.05	0.05	0.1	0.05	0.05
			a_p (mm)	0.1	0.1	0.05	0.2	0.2	0.1	0.25	0.25	0.1	0.3	0.3	0.1
			a_e (mm)	0.6	0.2	0.2	0.8	0.2	0.2	1	0.25	0.2	1.2	0.3	0.2
焼入れ鋼 Hardened steels 55~62HRC	TH308	PTH08M	n (min ⁻¹)	4,240	11,670	11,670	3,180	8,760	8,760	2,550	7,000	7,000	2,120	5,840	5,840
			V_c (m/min)	80	220	220	80	220	220	80	220	220	80	220	220
			V_f (mm/min)	680	930	930	640	880	880	510	700	700	420	580	580
			f_z (mm/t)	0.08	0.04	0.04	0.1	0.05	0.05	0.1	0.05	0.05	0.1	0.05	0.05
			a_p (mm)	0.1	0.1	0.05	0.2	0.2	0.1	0.25	0.25	0.1	0.3	0.3	0.1
			a_e (mm)	0.6	0.2	0.2	0.8	0.2	0.2	1	0.25	0.2	1.2	0.3	0.2
最大 Maximum f_z (mm/t)				<0.2			<0.5			<0.5			<0.5		
最大 Maximum a_p (mm)				<0.6			<2.5			<3.0			<4.0		

- [注意]** (1)被削材、加工形状に合わせて、適切なクーラントを使用してください。
(2)この切削条件表は切削条件の目安を示すものです。実際の加工では加工形状、目的、使用機械等により条件を調整してください。
(3)この工具をご使用の際は、破損する危険性がありますので、必ずカバー・保護めがね・安全靴等をご使用してください。
(4)超硬シャンクホルダには手を加えないでください。また、超硬シャンクホルダ使用時の切り込み量 a_p は、下記値にてご使用ください。
工具径DC12以下は、 $a_p=0.2$ mm以下。工具径DC16以上は、 $a_p=0.3$ mm以下。

- [Note]** 1. Use the appropriate coolant for the work material and machining shape.
2. These conditions are for general guidance; in actual machining conditions adjust the parameters according to your actual machine and work-piece conditions.
3. Be sure to practice safety instructions and precautions such as wearing glasses and safety shoes, and placing safety covers when you use this tool. Because this tool can be broken during machining so failure to follow these instructions may cause personal injury.
4. Never attempt to modify the carbide shank holder. Use the value for the depth of cut (a_p) when the carbide shank holder is used.
Tool dia. DC \leq 12mm: $a_p\leq$ 0.2mm. Tool dia. DC \geq 16mm: $a_p\leq$ 0.3mm.

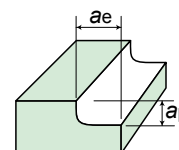

標準切削条件表

Recommended Cutting Conditions

※赤字は第一推奨材種です Red indicates primary recommended insert grade.

被削材 Work material	インサート材種 Insert grade		切削条件 Cutting conditions	φ16			φ20			φ25			φ30			φ32		
	SG-SW (ねじり刃形) (helical cutting edge inserts)	一般刃形 General edge shape		中仕上げ Semi finishing		仕上げ Finishing	中仕上げ Semi finishing		仕上げ Finishing	中仕上げ Semi finishing		仕上げ Finishing	中仕上げ Semi finishing		仕上げ Finishing	中仕上げ Semi finishing		仕上げ Finishing
				汎用 General purpose	高速加工 High-speed processing	汎用 General purpose	高速加工 High-speed processing	汎用 General purpose	高速加工 High-speed processing	汎用 General purpose	高速加工 High-speed processing	汎用 General purpose	高速加工 High-speed processing	汎用 General purpose	高速加工 High-speed processing	汎用 General purpose	高速加工 High-speed processing	
炭素鋼 合金鋼 Carbon steels Alloy steels (30HRC以下) (30HRC or less)	※ PN215 TH308	PTH08M (PCA12M)	n (min ⁻¹)	3,190	5,970	5,970	2,550	4,780	4,780	2,040	3,820	3,820	1,700	3,180	3,180	1,590	2,990	2,990
			Vc (m/min)	160	300	300	160	300	300	160	300	300	160	300	300	160	300	300
			Vf (mm/min)	1,600	2,390	2,390	1,280	1,910	1,910	1,020	1,530	1,530	850	1,270	1,270	800	1,200	1,200
			fz (mm/t)	0.25	0.2	0.2	0.25	0.2	0.2	0.25	0.2	0.2	0.25	0.2	0.2	0.25	0.2	0.2
			ap (mm)	0.8	0.8	0.2	1	1	0.2	1.25	1.25	0.2	1.6	1.6	0.2	1.6	1.6	0.2
			ae (mm)	1.6	1.6	0.2	2	2	0.2	2.5	2.5	0.2	3.2	3.2	0.2	3.2	3.2	0.2
炭素鋼 合金鋼 Carbon steels Alloy steels (30~45HRC)	TH308 PN215	PTH08M (PCA12M)	n (min ⁻¹)	2,390	5,570	5,570	1,910	4,460	4,460	1,530	3,570	3,570	1,270	2,970	2,970	1,190	2,790	2,790
			Vc (m/min)	120	280	280	120	280	280	120	280	280	120	280	280	120	280	280
			Vf (mm/min)	1,200	2,230	2,230	960	1,780	1,780	760	1,430	1,430	640	1,190	1,190	600	1,120	1,120
			fz (mm/t)	0.25	0.2	0.2	0.25	0.2	0.2	0.25	0.2	0.2	0.25	0.2	0.2	0.25	0.2	0.2
			ap (mm)	0.8	0.8	0.2	1	1	0.2	1.25	1.25	0.2	1.6	1.6	0.2	1.6	1.6	0.2
			ae (mm)	1.6	1.6	0.2	2	2	0.2	2.5	2.5	0.2	3.2	3.2	0.2	3.2	3.2	0.2
鋳鉄 Cast irons	TH308 PN215	PTH08M (PCA12M)	n (min ⁻¹)	3,190	7,560	7,560	2,550	6,050	6,050	2,040	4,840	4,840	1,700	4,030	4,030	1,590	3,780	3,780
			Vc (m/min)	160	380	380	160	380	380	160	380	380	160	380	380	160	380	380
			Vf (mm/min)	2,240	4,540	4,540	1,790	3,630	3,630	1,430	2,900	2,900	1,190	2,420	2,420	1,110	2,270	2,270
			fz (mm/t)	0.35	0.3	0.3	0.35	0.3	0.3	0.35	0.3	0.3	0.35	0.3	0.3	0.35	0.3	0.3
			ap (mm)	0.8	0.8	0.2	1	1	0.2	1.25	1.25	0.2	1.6	1.6	0.2	1.6	1.6	0.2
			ae (mm)	1.6	1.6	0.2	2	2	0.2	2.5	2.5	0.2	3.2	3.2	0.2	3.2	3.2	0.2
グラファイト Graphite	HD7010		n (min ⁻¹)	5,970	7,960	7,960	4,780	6,370	6,370	3,830	5,100	5,100	3,190	4,250	4,250	3,190	3,980	3,980
			Vc (m/min)	300	400	400	300	400	400	300	400	400	300	400	400	300	400	400
			Vf (mm/min)	2,990	4,780	3,980	2,390	3,820	3,190	1,920	3,060	2,550	1,600	2,550	2,130	1,600	2,390	1,990
			fz (mm/t)	0.25	0.3	0.25	0.25	0.3	0.25	0.25	0.3	0.25	0.25	0.3	0.25	0.25	0.3	0.25
			ap (mm)	0.8	0.6	0.2	1	0.7	0.2	1.25	1.25	0.2	1.6	1.6	0.2	1.6	1.6	0.2
			ae (mm)	1.6	1.1	0.3	2	1.5	0.4	2.5	2.5	0.4	3.2	3.2	0.4	3.2	3.2	0.4
アルミニウム 合金鋳物 Cast aluminum alloys AC4A, ADC12等 etc	PN215	HD7010	n (min ⁻¹)	5,970	9,950	9,950	4,780	7,960	7,960	3,830	6,370	6,370	3,190	5,310	5,310	3,190	4,980	4,980
			Vc (m/min)	300	500	500	300	500	500	300	500	500	300	500	500	300	500	500
			Vf (mm/min)	2,990	7,960	4,980	2,390	6,370	3,980	1,920	5,100	3,190	1,600	4,250	2,660	1,600	3,980	2,490
			fz (mm/t)	0.25	0.4	0.25	0.25	0.4	0.25	0.25	0.4	0.25	0.25	0.4	0.25	0.25	0.4	0.25
			ap (mm)	0.8	0.6	0.2	1	0.7	0.2	1.25	1.25	0.2	1.6	1.6	0.2	1.6	1.6	0.2
			ae (mm)	1.6	1.1	0.3	2	1.5	0.4	2.5	2.5	0.4	3.2	3.2	0.4	3.2	3.2	0.4
焼入れ鋼 Hardened steels 45~55HRC	TH308 PN215	PTH08M (PCA12M)	n (min ⁻¹)	1,990	5,570	5,570	1,590	4,460	4,460	1,270	3,570	3,570	1,060	2,970	2,970	1,000	2,790	2,790
			Vc (m/min)	100	280	280	100	280	280	100	280	280	100	280	280	100	280	280
			Vf (mm/min)	480	670	670	380	530	530	310	430	430	250	360	360	240	330	330
			fz (mm/t)	0.12	0.06	0.06	0.12	0.06	0.06	0.12	0.06	0.06	0.12	0.06	0.06	0.12	0.06	0.06
			ap (mm)	0.8	0.8	0.2	1	1	0.2	1.25	1.25	0.2	1.6	1.6	0.2	1.6	1.6	0.2
			ae (mm)	1.6	0.8	0.2	2	1	0.2	2.5	1.25	0.2	3.2	1.6	0.2	3.2	1.6	0.2
焼入れ鋼 Hardened steels 55~62HRC	TH308	PTH08M	n (min ⁻¹)	1,590	4,380	4,380	1,270	3,500	3,500	1,020	2,800	2,800	850	2,330	2,330	800	2,190	2,190
			Vc (m/min)	80	220	220	80	220	220	80	220	220	80	220	220	80	220	220
			Vf (mm/min)	380	530	530	300	420	420	240	340	340	200	280	280	190	260	260
			fz (mm/t)	0.12	0.06	0.06	0.12	0.06	0.06	0.12	0.06	0.06	0.12	0.06	0.06	0.12	0.06	0.06
			ap (mm)	0.8	0.8	0.2	1	1	0.2	1.25	1.25	0.2	1.6	1.6	0.2	1.6	1.6	0.2
			ae (mm)	1.6	0.8	0.2	2	1	0.2	2.5	1.25	0.2	3.2	1.6	0.2	3.2	1.6	0.2
最大 Maximum fz (mm/t)				<0.6			<0.6			<0.6			<0.6					
最大 Maximum ap (mm)				<5.0			<6.0			<8.0			<10.0					

※突き出し長3DC以上の場合は、
上記の表をもとに右記表を参考に
調整してください。

※If overhang length is 3DC or more,
make adjustments to the table above
according to the table at right.

突き出し量 Overhang	Vc (m/min)	Vf (mm/min)
<3DC	100%	100%
3DC~5DC	70%	70%
5DC~8DC	60%	60%
8DC~10DC	50%	50%

SGタイプ SG type

01 従来品との切削抵抗の比較 Cutting force comparison between conventional edge shape and high helix one.

ZCFG-SG(ねじれ刃形 helical cutting edge inserts)



インサート Insert : ZCFG200SG-R1.0

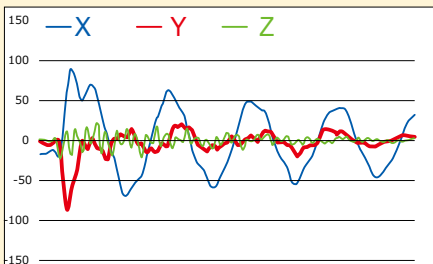

従来に比べ壁面から受ける切削抵抗(Y分力)が低く、変動も小さいので加工安定性が良い
Compared to conventional tools, the cutting resistance (Y part force) received from the wall surface is low and the variation is also small so machining stability is good.

従来品 Conventional

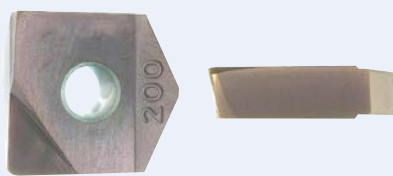

インサート Insert : ZCFW200-R1.0

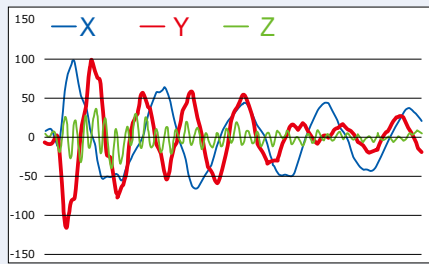

切削抵抗の変動が大きい。
Cutting resistance variation is large.

切削条件 Cutting conditions

被削材 : S50C (220HB)
カッタ : ARPFM20(工具径φ20-R1.0)
インサート : ZCFG200SG-R1.0(TH308)
ZCFW200-R1.0(PTH08M)
シャンク : ASC20-10.5-170-90Z (突出し量 : 140mm)
使用機械 : 縦型(BT50)
切削速度 : $V_c=200\text{m/min}$
一刃当りの送り量 : $f_z=0.15\text{mm/t}$
軸方向切込み(a_p)=1.0mm
径方向切込み(a_e)=0.1mm
加工形状 : 立壁(垂直)
クーラント : エア

Work material : S50C (220HB)
Cutter : ARPFM20(Tool dia. φ20-R1.0)
Insert : ZCFG200SG-R1.0(TH308)
ZCFW200-R1.0(PTH08M)
Shank : ASC20-10.5-170-90Z (Overhang : 140mm)
Machine : Vertical type(BT50)
Cutting speed : $v_c=200\text{m/min}$
Feed rate : $f_z=0.15\text{mm/t}$
Cutting depth(a_p)=1.0mm
Radial depth of cut(a_e)=0.1mm
Cutting shape : Standing wall (vertical)
Coolant : Air

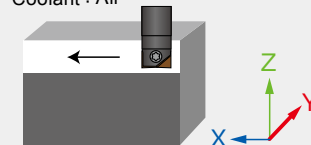

02 立壁中仕上げ加工時の工具寿命 Tool service life when performing semi-finishing of standing walls

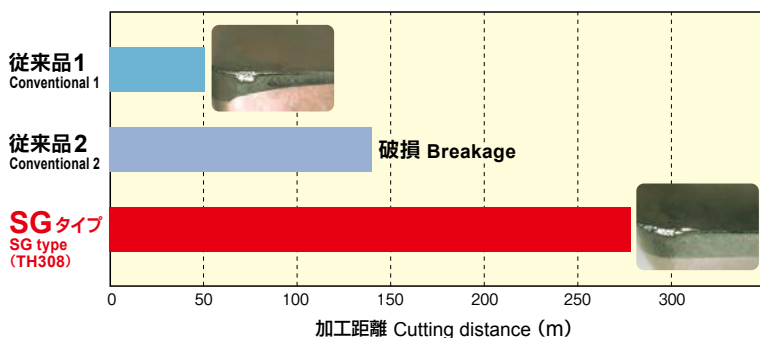

切削条件 Cutting conditions

被削材 : ステンレス系 (52HRC) Work material : stainless materials (52HRC)
カッタ : ARPFM20 (工具径φ20) Cutter : ARPFM20 (Tool dia. φ20)
シャンク : ASC20-10.5-120-50Z Shank : ASC20-10.5-120-50Z (突出し量 : 60mm)
使用機械 : 縦型 (BT50) Machine : Vertical type (BT50)
切削速度 : $V_c=120\text{m/min}$ Cutting speed : $v_c=120\text{m/min}$
一刃当りの送り量 : $f_z=0.25\text{mm/t}$ Feed rate : $f_z=0.25\text{mm/t}$
軸方向切込み (a_p) =1.0mm Cutting depth (a_p) =1.0mm
径方向切込み (a_e) =0.5mm Radial depth of cut (a_e) =0.5mm
加工形状 : 立壁 Cutting shape : Standing wall
クーラント : エア Coolant : Air

03 底面中仕上げ加工時の工具寿命 Tool service life when performing semi-finishing of bottom surface

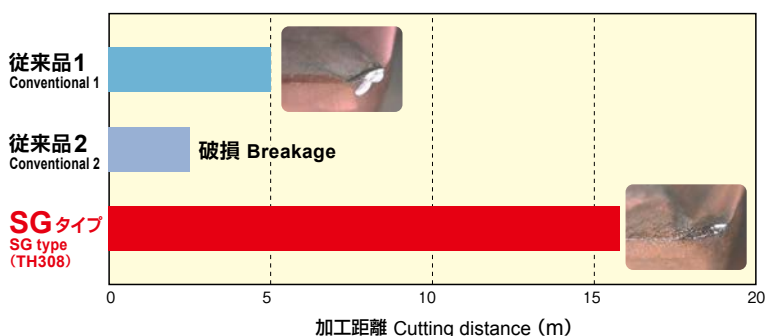

切削条件 Cutting conditions

被削材 : ステンレス系 (52HRC) Work material : stainless materials (52HRC)
カッタ : ARPFM20 (工具径φ20) Cutter : ARPFM20 (Tool dia. φ20)
シャンク : ASC20-10.5-120-50Z Shank : ASC20-10.5-120-50Z (突出し量 : 60mm)
使用機械 : 縦型 (BT50) Machine : Vertical type (BT50)
切削速度 : $V_c=120\text{m/min}$ Cutting speed : $v_c=120\text{m/min}$
一刃当りの送り量 : $f_z=0.25\text{mm/t}$ Feed rate : $f_z=0.25\text{mm/t}$
軸方向切込み (a_p) =0.5mm Cutting depth (a_p) =0.5mm
径方向切込み (a_e) =10mm Radial depth of cut (a_e) =10mm
加工形状 : 平面 Cutting shape : Planing
クーラント : エア Coolant : Air

切削性能

Cutting performance

SWタイプ SW type

立壁削り残し量の推移 Remaining stock when cutting standing walls

※立壁を120分間加工した場合の削り残し量を従来品と比較。
 ※Comparison of remaining stock with conventional products when the standing wall was machined for 120 minutes.

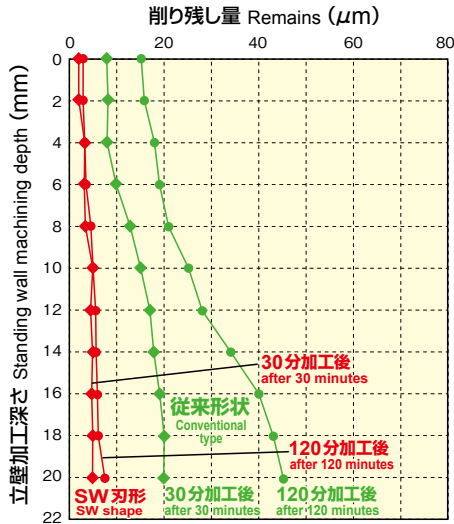

SWタイプ(PN215)は、120分加工しても削り残し量は10μm以下、加工面品位も良好。
 With SW type(PN215), even after machining for 120 minutes, the remaining stock was 10μm or less and cut surface quality is good.

切削条件 Cutting conditions

被削材: S50C (220HB)	Work material: S50C (220HB)
カッタ: ARPFM20 (工具径φ20)	Cutter: ARPFM20 (Tool dia. φ20)
シャンク: ASC20-10.5-170-90Z (突出し量: 140mm)	Shank: ASC20-10.5-170-90Z (Overhang: 140mm)
使用機械: 縦型 (BT50)	Machine: Vertical type (BT50)
切削速度: $V_c=200\text{m/min}$	Cutting speed: $V_c=200\text{m/min}$
一刃当りの送り量: $f_z=0.15\text{mm/t}$	Feed rate: $f_z=0.15\text{mm/t}$
軸方向切込み (a_p) = 1.0mm	Cutting depth (a_p) = 1.0mm
径方向切り込み (a_e) = 0.1mm	Radial depth of cut (a_e) = 0.1mm
加工形状: 立壁 (垂直)	Cutting shape: Standing wall (vertical)
クーラント: エア	Coolant: Air

120min後加工面拡大 Magnified view of surface after 120 minutes of machining

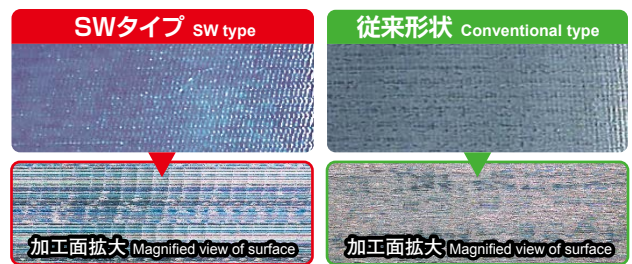

光沢面 Shiny surface

曇り面 Cloudy surface

切削事例 Field data

01 S50C [220HB] における V_c -T 線図 V_c -T chart for S50C [220HB]

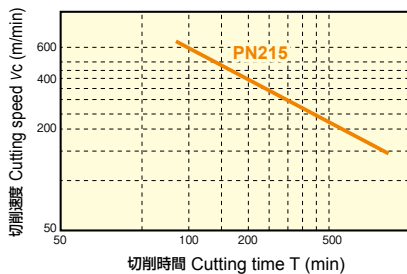

切削条件 Cutting conditions

被削材: S50C (220HB)	Work material: S50C (220HB)
使用工具 カッタ: ARPFM20(φ20)	Tool Cutter: ARPFM20(φ20)
シャンク: ASC20-10.5-120-50Z	Shank: ASC20-10.5-120-50Z
インサート: ZCFG200SG-R1.0(PN215)	Insert: ZCFG200SG-R1.0(PN215)
突出し量: 80mm	Overhang: 80mm
一刃当りの送り量: $f_z=0.15\text{mm/t}$	Feed rate: $f_z=0.15\text{mm/t}$
切込み: $a_p \times a_e = 1 \times 0.1\text{mm}$	Radial depth of cut: $a_p \times a_e = 1 \times 0.1\text{mm}$
使用機械: 縦型(BT50)、加工形状: 立壁	Machine: Vertical type(BT50)
クーラント: エア	Coolant: Air

02 SKD61 [45HRC] における V_c -T 線図 V_c -T chart for SKD61 [45HRC]

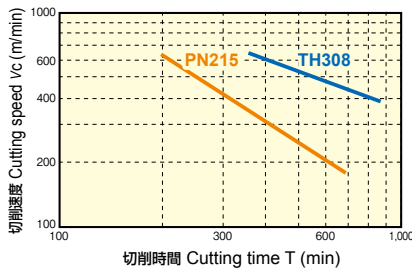

切削条件 Cutting conditions

被削材: SKD61 (45HRC)	Work material: SKD61 (45HRC)
使用工具 カッタ: ARPFM20(φ20)	Tool Cutter: ARPFM20(φ20)
シャンク: ASC20-10.5-120-50Z	Shank: ASC20-10.5-120-50Z
インサート: ZCFG200SG-R1.0(PN215) ZCFG200SG-R1.0(TH308)	Insert: ZCFG200SG-R1.0(PN215) ZCFG200SG-R1.0(TH308)
突出し量: 80mm	Overhang: 80mm
一刃当りの送り量: $f_z=0.15\text{mm/t}$	Feed rate: $f_z=0.15\text{mm/t}$
切込み: $a_p \times a_e = 1 \times 0.1\text{mm}$	Radial depth of cut: $a_p \times a_e = 1 \times 0.1\text{mm}$
使用機械: 縦型(BT50)、加工形状: 立壁	Machine: Vertical type(BT50)
クーラント: エア	Coolant: Air

03 SKD11 [60HRC] における V_c -T 線図 V_c -T chart for SKD11 [60HRC]

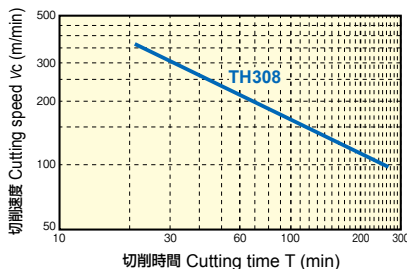

切削条件 Cutting conditions

被削材: SKD11 (60HRC)	Work material: SKD11 (60HRC)
使用工具 カッタ: ARPFM20(φ20)	Tool Cutter: ARPFM20(φ20)
シャンク: ASC20-10.5-120-50Z	Shank: ASC20-10.5-120-50Z
インサート: ZCFG200SG-R1.0(TH308)	Insert: ZCFG200SG-R1.0(TH308)
突出し量: 80mm	Overhang: 80mm
一刃当りの送り量: $f_z=0.15\text{mm/t}$	Feed rate: $f_z=0.15\text{mm/t}$
切込み: $a_p \times a_e = 1 \times 0.1\text{mm}$	Radial depth of cut: $a_p \times a_e = 1 \times 0.1\text{mm}$
使用機械: 縦型(BT50)、加工形状: 立壁	Machine: Vertical type(BT50)
クーラント: エア	Coolant: Air

実績は語る

Field data

加工事例 Cutting examples	切削条件 Cutting conditions	結果 Result
<p>プラスチック金型の加工 Plastic mold</p> 	<p>使用工具 Tool : ARPF20S20WE (OH=150mm) 被削材 Work material : 炭素鋼 Carbon steels 使用インサート Insert : ZCFG200SG-R1.0 (PN215) 使用機械 Machine : 縦型 Vertical type M/C (BT50) 切削速度 Cutting speed : $V_c=220\text{m/min}$ 回転数 Revolution : $n=3500\text{min}^{-1}$</p> <p>送り速度 Feed speed : $V_f=1750\text{mm/min}$ 一刃当たりの送り量 Feed rate : $f_z=0.25\text{mm/t}$ 軸方向切込み Cutting depth : $a_p=0.2\text{mm}$ 径方向切込み Radial depth of cut : $a_e=0.1\text{mm}$ 切削油剤 Coolant : 乾式 Dry (エア Air)</p>	<p>6時間使用し刃先は定常摩耗にて良好。仕上げ面も従来品と比較し良好。 After 6 hours, the cutting edge is good with normal wear. The finished surface is also good compared with conventional products.</p>
<p>プラスチック金型 (S50C) の加工 Plastic mold (S50C)</p> 	<p>使用工具 Tool : ARPFM20 + ASC20-10.5-120-50Z (OH=90mm) 被削材 Work material : 炭素鋼 Carbon steels 使用インサート Insert : ZCFG200SG-R1.0 (PN215) 使用機械 Machine : 縦型 Vertical type M/C (BT50) 切削速度 Cutting speed : $V_c=188\text{m/min}$ 回転数 Revolution : $n=3000\text{min}^{-1}$</p> <p>送り速度 Feed speed : $V_f=1500\text{mm/min}$ 一刃当たりの送り量 Feed rate : $f_z=0.25\text{mm/t}$ 軸方向切込み Cutting depth : $a_p=0.3\text{mm}$ 径方向切込み Radial depth of cut : $a_e=0.4\text{mm}$ 切削油剤 Coolant : 乾式 Dry (エア Air)</p>	<p>削り代の不均一中仕上げ加工を7時間行ったが刃先はチッピングすることなく良好。 Even after performing semi-finishing with non-uniform cutting for 7 hours, the cutting edge is good with no chipping.</p>
<p>ダイキャスト金型 (ポケット部) の加工 Machining of die-casting mold (pocket area)</p> 	<p>使用工具 Tool : ARPFM20+ASC20-10.5-220-120Z (OH=160mm) 被削材 Work material : SKD61相当 Equivalent to SKD61 (40 ~ 43HRC) 使用インサート Insert : ZCFG200SW-R1.0 (TH308) 使用機械 Machine : 縦型 Vertical type M/C (BT50)</p> <p>■側面部 side wall 切削速度 Cutting speed : $V_c=182\text{m/min}$ 回転数 Revolution : $n=2900\text{min}^{-1}$ 送り速度 Feed speed : $V_f=600\text{mm/min}$ 一刃当たりの送り量 Feed rate : $f_z=0.1\text{mm/t}$ 軸方向切込み Cutting depth : $a_p=0.1\text{mm}$ 径方向切込み Radial depth of cut : $a_e=0.1\text{mm}$</p>	<p>側面部、平面部ともに加工精度良好。従来の刃先交換式工具は、加工精度に課題があった。 Machining accuracy for both side surface areas and flat surface areas is good. With conventional indexable tools, machining accuracy had been a problem.</p>
<p>ダイキャスト金型の加工 Machining of die-casting mold</p> 	<p>使用工具 Tool : ARPFM20+ASC20-10.5-170-90Z (OH=130mm) 被削材 Work material : SKD61 (45HRC) 使用インサート Insert : ZCFG200SG-R1.0 (PN215) 使用機械 Machine : 縦型 Vertical type M/C (BT50) 切削速度 Cutting speed : $V_c=88\text{m/min}$ 回転数 Revolution : $n=1400\text{min}^{-1}$</p> <p>送り速度 Feed speed : $V_f=280\text{mm/min}$ 一刃当たりの送り量 Feed rate : $f_z=0.1\text{mm/t}$ 軸方向切込み Cutting depth : $a_p=0.5\text{mm}$ 径方向切込み Radial depth of cut : $a_e=1\text{mm}$ 切削油剤 Coolant : 乾式 Dry (エア Air)</p>	<p>コーナ部などの削り代が不均一な加工でも刃先はチッピングすることなく良好。 Even when machining corner areas where cutting amount is non-uniform, the cutting edge is good with no chipping.</p>
<p>ダイキャスト金型 (構造部) の加工 Machining of die-casting mold (structural area)</p> 	<p>使用工具 Tool : ARPFM20+ASC20-10.5-170-90Z (OH=130mm) 被削材 Work material : SKD61 (45HRC) 使用インサート Insert : ZCFG200SG-R1.0 (TH308) 使用機械 Machine : 縦型 Vertical type M/C (BT50) 切削速度 Cutting speed : $V_c=200\text{m/min}$ 回転数 Revolution : $n=3200\text{min}^{-1}$</p> <p>送り速度 Feed speed : $V_f=1600\text{mm/min}$ 一刃当たりの送り量 Feed rate : $f_z=0.25\text{mm/t}$ 軸方向切込み Cutting depth : $a_p=0.2\text{mm}$ 径方向切込み Radial depth of cut : $a_e=0.1\text{mm}$ 切削油剤 Coolant : 乾式 Dry (エア Air)</p>	<p>仕上げ加工1回で規定の寸法公差に仕上がった。従来品は、びびり易く、削り残りが発生するため再加工が必要であった。 Performing finishing once resulted in finishing that was within the specified dimensional tolerance. With conventional products, chattering often occurred and there were uncut areas so re-machining was necessary.</p>



図、表等のデータは試験結果の一例であり、保証値ではありません。
「MOLDINO」は株式会社MOLDINOの登録商標です。

The diagrams and table data are examples of test results, and are not guaranteed values.
"MOLDINO" is a registered trademark of MOLDINO Tool Engineering, Ltd.

安全上のご注意 Attention on Safety

1. 取扱上のご注意

- (1) 工具をケース(梱包)から取り出す際は、足元への落下あるいは素手の指先へ落ちて怪我をしないように十分なご注意をお願いします。
- (2) インサートをセットして実際にご使用する場合は、切れ刃を素手で直接触れないように注意してください。

2. 取付け時のご注意

- (1) ご使用にあたって、インサートのセッティングは確実に行っていただき、アーク等への取付けも確実に行ってください。
- (2) ご使用中に、異常な振動等が発生した場合は、直ちに機械を停止させて、その振動の原因を除いてください。

3. 使用上のご注意

- (1) 切削工具あるいは被削材の寸法・回転の方向は、あらかじめ確認しておいてください。
- (2) 標準切削条件表の数値は、新しい作業の立上げの目安としてご利用ください。切込みが大きい場合、使用機械の剛性が小さい場合あるいは被加工物の性状に応じて切削条件を適正に調整してご使用ください。
- (3) インサートは硬質の材料です。ご使用中に破損して飛散する場合があります。また、切りくずが飛散することがあります。これらの飛散物等は作業者を切傷させ、火傷あるいは目に入って負傷させる恐れがありますので、工具をご使用中はその周囲に安全カバーを取付け、保護メガネ等の保護具を着用して安全な環境下での作業をお願いします。
 - ・引火や爆発の危険のあるところでは使用しないでください。
 - ・不水溶性切削油は、火災の恐れがありますので使用しないでください。
- (4) 工具を本来の目的以外に使用したり、改造したりしないでください。

- 4. 工具に関して、安全上の問題点・不明の点・その他ご相談がありましたら「フリーダイヤル技術相談」へお問い合わせください。

1. Attention regarding handling

- (1) When removing the tool from the case (package), be careful not to drop it on your foot or drop it onto the tips of your bare fingers.
- (2) When actually setting the inserts, be careful not to touch the cutting flute directly with your bare hands.

2. Attention regarding mounting

- (1) When preparing for use, be sure that the inserts are firmly mounted in place and that they are firmly mounted on the arbor, etc.
- (2) If abnormal chattering occurs during use, stop the machine immediately and remove the arbor of the chattering.

3. Attention during use

- (1) Before use, confirm the dimensions and direction of rotation of the tool and milling work material.
- (2) The numerical values in the standard cutting conditions table should be used as criteria when starting new work. The cutting conditions should be adjusted as appropriate when the cutting depth is large, the rigidity of the machine being used is low, or according to the conditions of the work material.
- (3) The inserts are made of a hard material. During use, they may break and fly off. In addition, cutting chips may also fly off. Since there is a danger of injury to workers, fire, or eye damage from such flying pieces, a safety cover should be installed and safety equipment such as safety glasses should be worn to create a safe environment for work.
 - ・ Do not use where there is a risk of fire or explosion.
 - ・ Do not use non-water-soluble cutting oils. Such oils may result in fire.
- (4) Do not use the tool for any purpose other than that for which it is intended, and do not modify it.

株式会社 MOLDINO

MOLDINO Tool Engineering, Ltd.

本社 〒130-0026 東京都墨田区両国4-31-11(ヒューリック両国ビル8階)

☎ 03-6890-5101 FAX 03-6890-5134

International Sales Dept.: ☎ +81-3-6890-5103 FAX +81-3-6890-5128

営業企画部	☎ 03-6890-5102 FAX03-6890-5134	海外営業部	☎ 03-6890-5103 FAX03-6890-5128
東京営業所	☎ 03-6890-5110 FAX03-6890-5133	静岡営業所	☎ 054-273-0360 FAX054-273-0361
東北営業所	☎ 022-208-5100 FAX022-208-5102	名古屋営業所	☎ 052-687-9150 FAX052-687-9144
新潟営業所	☎ 0258-87-1224 FAX0258-87-1158	大阪営業所	☎ 06-7668-0190 FAX06-7668-0194
東関東営業所	☎ 0294-88-9430 FAX0294-88-9432	中四営業所	☎ 082-536-2001 FAX082-536-2003
長野営業所	☎ 0268-21-3700 FAX0268-21-3711	九州営業所	☎ 092-289-7010 FAX092-289-7012
北関東営業所	☎ 0276-59-6001 FAX0276-59-6005		
神奈川営業所	☎ 046-400-9429 FAX046-400-9435		

ヨーロッパ / MOLDINO Tool Engineering Europe GmbH Itterpark 12, 40724 Hilden, Germany. TEL : +49-(0)2103-24820. FAX : +49-(0)2103-248230
 アメリカ / MITSUBISHI MATERIALS U.S.A. CORPORATION 41700 Gardenbrook Road, Suite 120, Novi, MI 48375-1320 U.S.A. TEL : +1(248)308-2620. FAX : +1(248)308-2627
 メキシコ / MMC METAL DE MEXICO, S.A. DE C.V. Av. La Cañada No.16, Parque Industrial Bernardo Quintana, El Marques, Querétaro, CP 76246, México TEL : +52-442-1926800
 ブラジル / MMC METAL DO BRASIL LTDA. Rua Cincinato Braga, 340 13º andar, Bela Vista - CEP 01333-010 São Paulo - SP, Brasil TEL : +55(11)3506-5600 FAX : +55(11)3506-5677
 タイ / MMC Hardmetal (Thailand) Co., Ltd. MOLDINO Division 622 Emporium Tower, Floor 22/14, Sukhumvit Road, Klong Tan, Klong Toei, Bangkok 10110, Thailand TEL : +66-(0)2-661-8175 FAX : +66-(0)2-661-8176
 インド / MMC Hardmetal India Pvt Ltd. H.O.: Prasad Enclave, #118/119, 1st Floor, 2nd Stage, 5th main, BBMP Ward #11, (New #38), Industrial Suburb, Yeshwanthpura, Bengaluru, 560 022, Karnataka, India. Tel : +91-80-2204-3600

ホームページ フリーダイヤル技術相談

http://www.moldino.com

☎ 0120-134159

工具選定データベース [TOOL SEARCH]

TOOLSEARCH

検索

店名

掲載価格は2022年10月1日改定後の消費税抜きの単価を表示しております。予告なく、改良・改善のために仕様変更することがあります。 Specifications for the products listed in this catalog are subject to change without notice due to replacement or modification.

VEGETABLE OIL INK ベジタブルインクで印刷しています。 Printed using vegetable oil ink.

2023-6 (ME-GT3) Printed in JAPAN 2009-1:FP